

Gate Valve Class 900 – ARTEK GROUP SRL

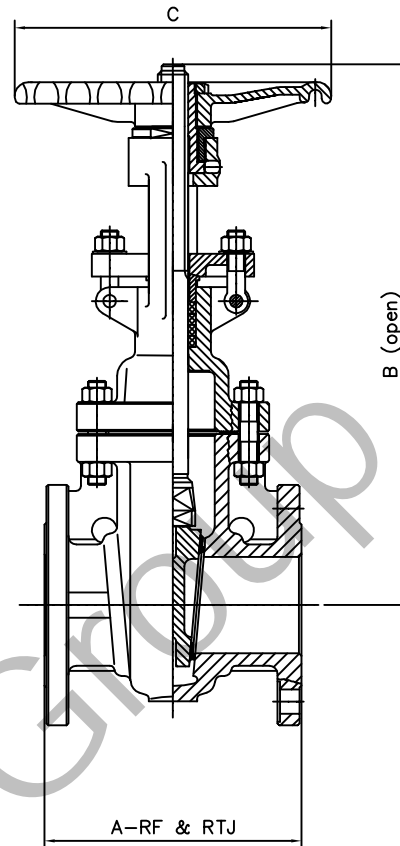

DESIGN AND MATERIALS ACC.TO NACE 0175/ISO 15156 LATEST EDITION
 FLANGED AND CONNECTIONS ACC.TO ANSI B16.5 / ANSI B16.25
 FACE TO FACE ACC.TO ANSI B16.10
 FLANGE FACING ACC.TO SMOOTH FINISH 125-250 AARH
 VALVE DESIGN API 600
 FULLY COMPLIANCE WITH PED 97/23/EC
 TEST AND INSPECTION API 598
 PRESSURE AND TEMP.RATING ANSI B16.34

Typical Bill for GATE

Component	TY1	TY2	TY3	Component	TY1	TY2	TY3
Body	ASTM A216WCB	ASTM A351CF8M	ASTM A351CF3M	Gland Flange	ASTM A216WCB	ASTM A351CF8M	ASTM A351CF3M
Seat Rings	ASTM A182F6+STL.6	ASTM A182F304L+STL.6	ASTM A182F316L+STL.6	Gland Bolt Pins	ASTM A105	ASTM A182F304L	ASTM A182F316L
Wedge	ASTM A216WCB+STL.6	ASTM A351CF8M+STL.6	ASTM A351CF3M+STL.6	Gland Bolts	ASTM A193-B7	ASTM A193-B8	ASTM A193-B8M
Stern	ASTM A182F6	ASTM A182F304L	ASTM A182F316L	Gland Nuts	ASTM A194-2H	ASTM A194-GR.8	ASTM A194-GR.8M
Bonnet	ASTM A216WCB	ASTM A351CF8M	ASTM A351CF3M	Nameplate	Stainless Steel	Stainless Steel	Stainless Steel
Bonnet Gasket	SS316+Graphite	SS316+Graphite	SS316+Graphite	Grease Fitting	ASTM A105	ASTM A182F304L	ASTM A182F316L
Bonnet Nuts	ASTM A194-2H	ASTM A194-GR.8	ASTM A194-GR.8M	Yoke Bushing	ASTM A105	ASTM A182F304L	ASTM A182F316L
Bonnet Studs	ASTM A193-B7	ASTM A193-B8	ASTM A193-B8M	Handwheel	Ductile Iron	ATSM A105	ASTM A105
Back Seat Bushing	ASTM A182F6	ASTM A182F304L	ASTM A182F316L	Handwheel Nut	ASTM A194-2H	ASTM A194-GR.8	ASTM A194-GR.8M
Packing	Braded & Flex. Graphite	Braded & Flex. Graphite	Braded & Flex. Graphite	Set Screw	ASTM A106-GR.8	ASTM A182F304L	ASTM A182F316L
Gland	ASTM A105	ASTM A182F304L	ASTM A182F316L				

Class 900

Size	nps	2	2.5	3	4	6	8	10	12
	dn	50	65	75	100	150	200	250	300
A-RF	in	14.5	16.5	15.0	18.0	24.0	29.0	33.0	38.0
	mm	368	419	381	457	610	737	838	965
A-BW	in	14.5	16.5	15.0	18.0	24.0	29.0	33.0	38.0
	mm	368	419	381	457	610	737	838	965
A-RTJ	in	14.62	16.62	15.12	18.12	24.12	29.12	33.12	38.12
	mm	371	422	384	460	612	740	841	968
B	in	21.7	26.0	23.7	27.6	38.4	45.5	52.6	59.8
	mm	551	660	602	701	975	1156	1336	1519
C	in	9.8	9.8	13.8	13.8	22.0	25.2	30.0	30.0
	mm	250	250	350	350	560	640	760	760
RF	lbs	135	175	255	453	913	1705	2387	3600
Wt.	kg	61	385	116	206	415	775	1085	1636
BW	lbs	125	155	213	396	807	1485	1724	2790
Wt.	kg	57	70	97	180	367	665	784	1268